

EN/CN-A01

Finder 3 发现者3

用户使用手册

USER GUIDE

中文P20

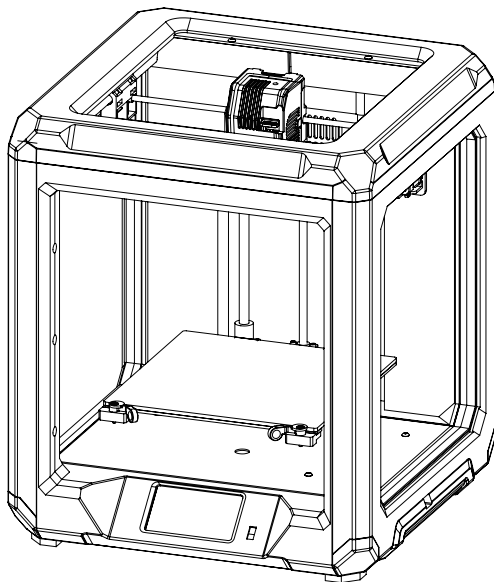

This guide is only applicable to FLASHFORGE Finder 3 3D printer

本手册仅适用于闪铸科技 发现者3 3D打印机

Content

Notes	02
Legal Statement	02
Equipment Parameters	03
Unpacking	04
Chapter 1 Equipment Introduction _____	05
1.1 - Product Introduction	05
1.2 - Kit Contents	06
Chapter 2 Preparation for Printing _____	07
2.1 - Assemble filament	07
2.2 - Build Plate	08
2.3 - Power On	08
2.4 - Leveling Build Plate	09
2.5 - Loading Filament	11
2.6 - Software Installation	11
Chapter 3 First Print _____	12
3.1 - Print	12
3.2 - Unloading Filament	13
3.3 - Wi-Fi Connection	13
3.4 - Connect Printer by Wi-Fi	14
3.5 - Firmware Upgrade	15
3.6 - Printing Notice	16
Chapter 4 FAQ _____	17
Chapter 5 Support and Service _____	19

Notes

1. Do not make any modifications to the printer. To avoid personal injury or property damage please ensure your operation followed by the Manual.
2. Dress properly. Do not wear loose clothing or jewelry. Keeping your hair, clothing and gloves away from moving parts.
3. Do not directly touch the nozzle and build plate to avoid high-temperature burn.
4. Do not expose the printer in flammable liquid, gas or dust environment (The high temperature generated by operating printer may react with dust, liquid, and flammable gas in the air and cause fire).
5. Do not put the printer on a shaking place. It may affect the printing quality.
6. Children and untrained personnel are not allowed to operate the printer alone.
7. Operate the printer in a well-ventilated environment. Some materials may emit odors during the printing process.
8. Do not manually move the nozzle or printing platform while booting up, lest printer damage.
9. Never use the printer for illegal activities.
10. Never use the printer to make any food storage.
11. Never put the printed model into mouth.
12. Lower the build plate before loading/unloading filament. The distance between the nozzle and build plate should be at least 50 mm.
13. Ensure regular maintenance for the printer; use dry cloth to remove dust and adhered residues.

Legal Statement

- ◆ The user has no right to make any modification to this user guide.
- ◆ Flashforge will not be responsible for any safety accidents caused by disassembly or modification of the equipment by the customer. No one is allowed to modify or translate this guide without the permission of Flashforge.
- ◆ This guide is protected by copyright, and Flashforge reserves the right of final interpretation of this guide.
- ◆ Flashforge reserves the right to modify the guide due to subsequent equipment upgrades.
- ◆ First Edition (January 2022)
©Copyright 2021 Zhejiang Flashforge 3D Technology Co., Ltd. All Rights Reserved.

Equipment Parameters

Model	Finder 3
Print volume	190*195*200mm
Forming technology	FDM
Extruder quantity	1
Layer thickness	0.1mm-0.4mm
Nozzle diameter	Standard 0.4mm
Print precision	±0.2mm
Filament	φ1.75mm PLA / PETG / TPU
File format	stl / obj / amf /3mf / fpp / bmp /png / jpg / jpeg
Connectivity	Internal memory printing / USB stick printing /W i-Fi connection printing
Slicing software	FlashPrint / Cura / Simplify 3D
Power specification	Input AC 115/230V 50/60Hz Output DC 24V
Total power	350W
Hotbed temperature	≤110°C
Nozzle temperature	≤260°C
Resume printing function	Yes
Filament detection sensor	Yes
Screen	4.3" colorful touchscreen
Language switch	Chinese / English / Japanese / French / Spanish / German
Supports(OS)	Windows 7/10 / Mac OS
Print speed	≤180mm/s, 50-80mm/s normally
Position precision	Z-axis 0.0025mm, X/Y-axis ±0.011mm
Output file	.gx / .g / .gcode

Unpacking

1. Open the box, take out the user manual and the USB flash disk.
2. Remove the foam.
3. Lift the printer and put it on the desk, then take Finder 3 out of the plastic bag.
4. Remove the top foam, there should be a power cable included.
5. Take out the foam under nozzle.
6. Hold the platform and lift it carefully to remove the foam below it.
7. Discard the protective tapes all around.
8. Cut the cable ties which for fixing X-axis and Y-axis synchronous belt.
9. Cut the cable ties that used to hold the rods in place.
10. Cut the cable ties that used to hold the platform. Discard the protective tape around it.
11. You've unpacked your printer. Please keep the kit and packing for future use.

Chapter 1 Equipment Introduction

1.1 Product Introduction

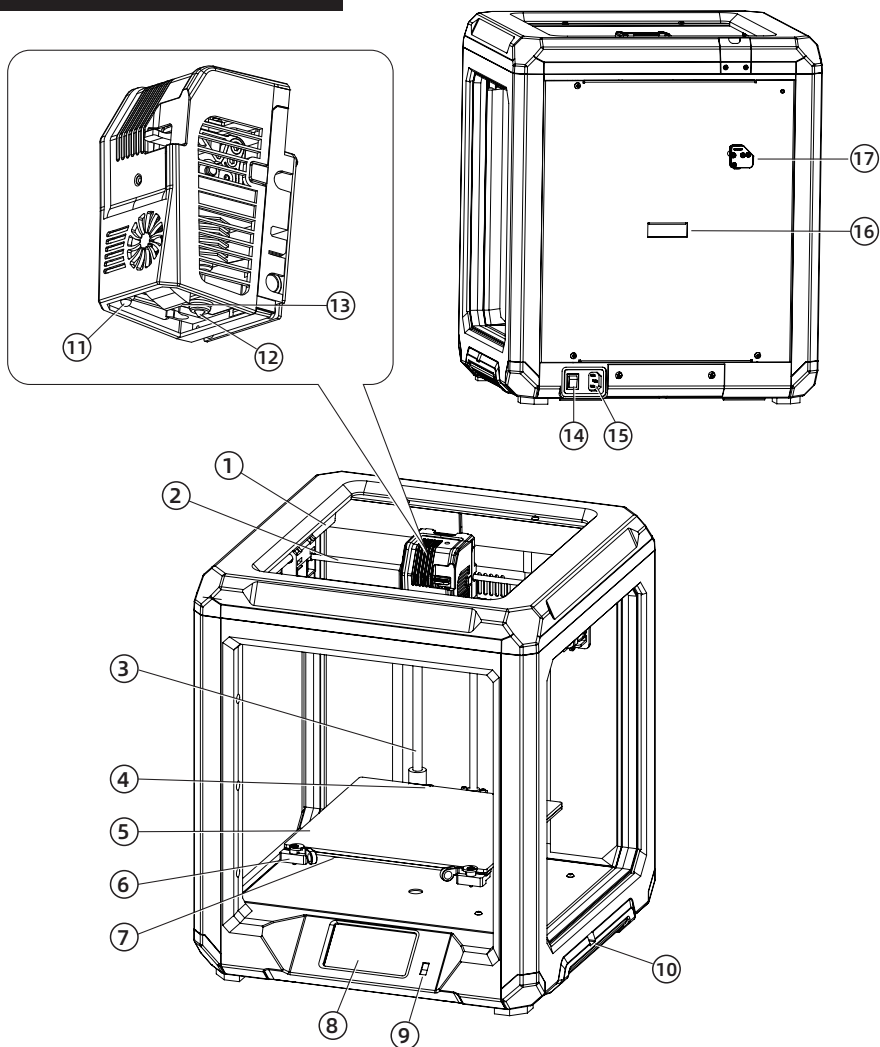

- | | | | |
|----------------------------|--------------------------|----------------------|-----------------------------|
| 1. Y-axis Guide Rail | 2. X-axis Guide Rail | 3. Z-axis Guide Rail | 4. Limit position assembly |
| 5. Glass platform | 6. Clip | 7. Leveling Nut | 8. Touch Screen |
| 9. USB Stick Input | 10. Power Voltage Switch | 11. LED Light | 12. Nozzle |
| 13. Turbofan Baffle | 14. Power Switch | 15. Power Input | 16. Spool installation port |
| 17. Filament detect sensor | | | |

1.2 Kit Contents

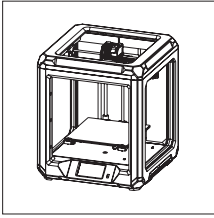

3D Printer

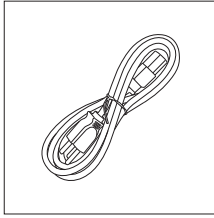

Power Cable



Filament



User Guide

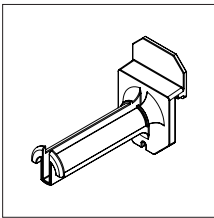

Material Rack

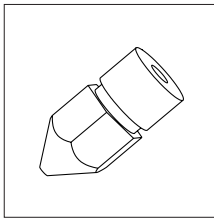

Nozzle

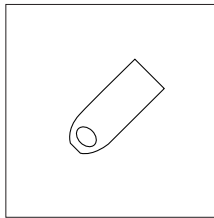

USB Flash Disk

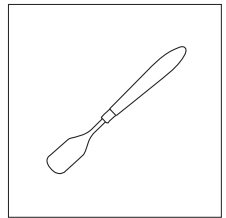

Remove Tool

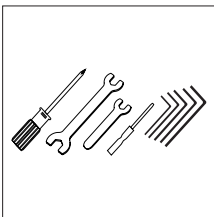

Wrenches and Screwdrivers

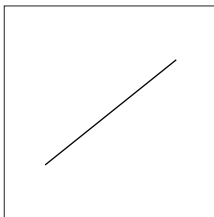

Needle

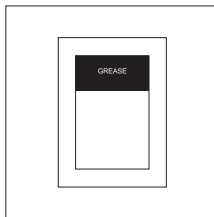

Grease

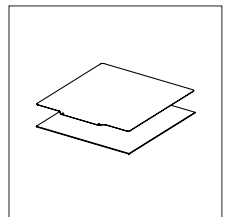

Flexible Spring Sheet

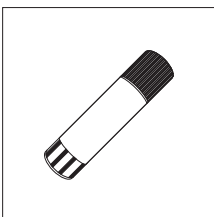

Glue

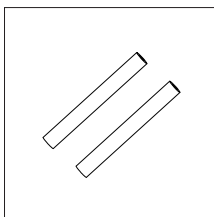

PTFE Tube

Chapter 2 Preparation for Printing

2.1 Assemble filament

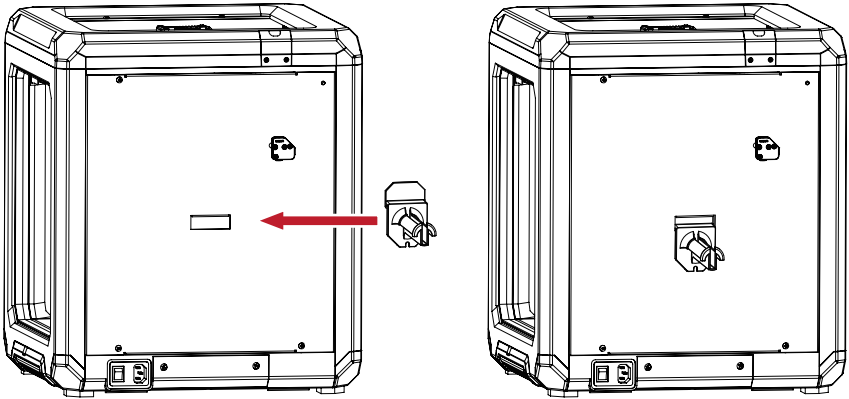

1. Install the material rack on the back of printer.

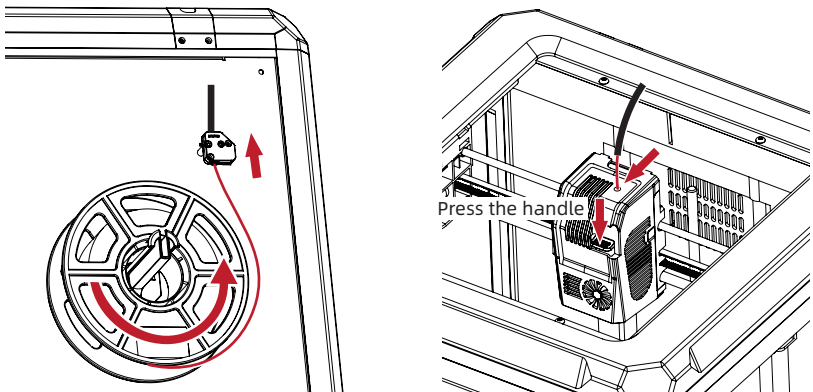

2. Insert the filament into the intake, pull out the PTFE tube from extruder; Then press the handle to push filament into filament feeding roller.

2.2 Build Plate

Finder 3 is installed with the glass platform by default, while users can also use the flexible removable platform.

Glass platform: The bottom is flatter, but the removal of the model requires a scraper; if the glass platform is used when the ambient temperature is low, it is recommended to apply glue on it before printing to increase the adhesion.

Flexible removable platform: It adopts magnetic adsorption, thus the model can be easily removed by removing the flexible steel plate and then bending it.

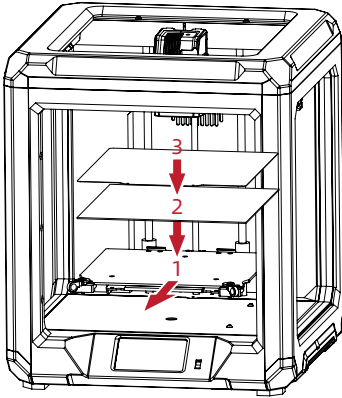

Installation method of the flexible removable platform plate:

1. Remove the glass platform.
2. Stick the magnet above the heating plate.
3. Then the flexible steel plate can be absorbed on the magnet.

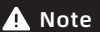

Note If you switch from the glass platform to the flexible removable platform plate, it is necessary to perform leveling and calibration.

2.3 Power On

Plug in the power cord and toggle the switch to turn on the power. Do not disconnect the cables when Finder 3 is powered on.

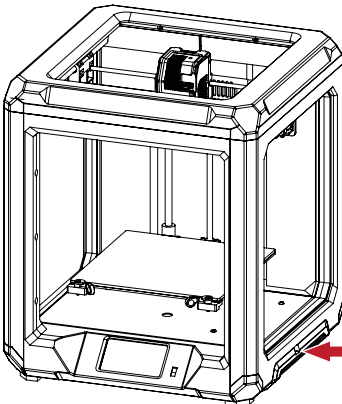

Attention

- Damage might occur if voltage setting is incorrect. Make sure the current input voltage matches to your local power supply (115/230V).
- Plug in power cord and turn power switch to 1 to turn it on.



2.4 Leveling Build Plate

Click [settings]-[Language] to switch the language.

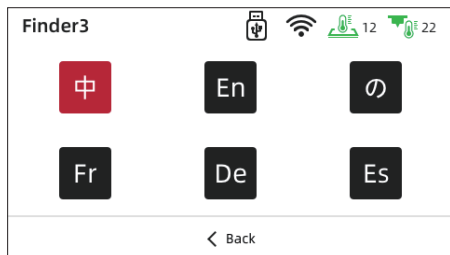
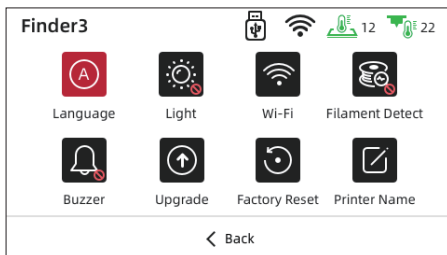
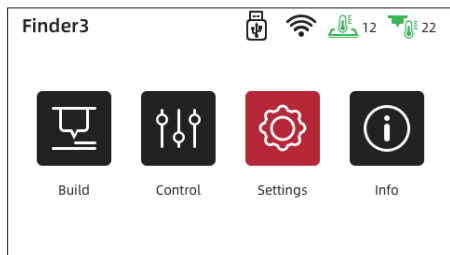

How to use the nuts

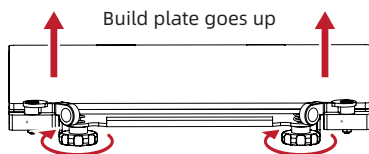

Rotate the nuts clockwise

Raise the build plate to reduce the distance between the nozzle and build plate.

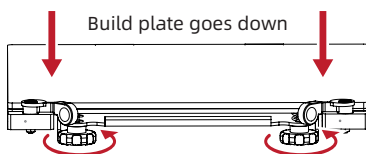

Rotate the nuts Anticlockwise

Lower the build plate to increase the distance between the nozzle and build plate.

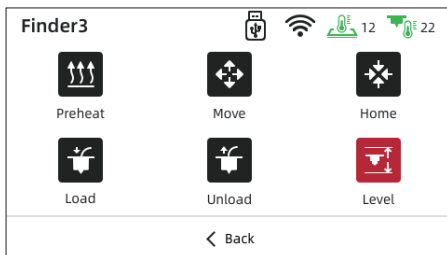
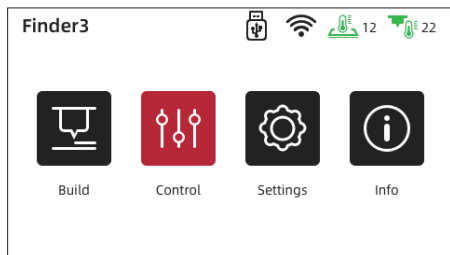

1. Put a piece of A4 paper on the build plate, tap the touchscreen [Control] - [Level] and wait for the extruder moving to the first leveling point.

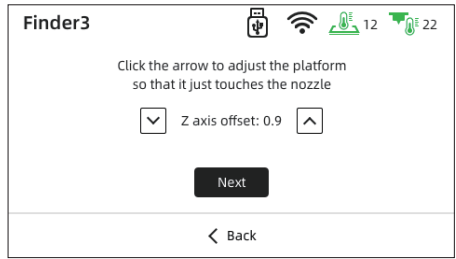

2. Lightly pull the A4 paper and feel the friction. If the friction is too big to move, tap [↓] to increase the distance between nozzle and build plate; if the friction is too small, tap [↑] to reduce the distance between nozzle and build plate. It is better that pull the paper to feel the significant frictional resistance until the slight scratches appear without damage. Tap [Next] to do the second level point.

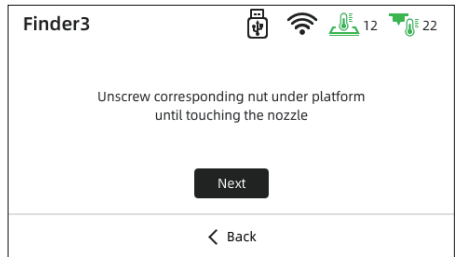
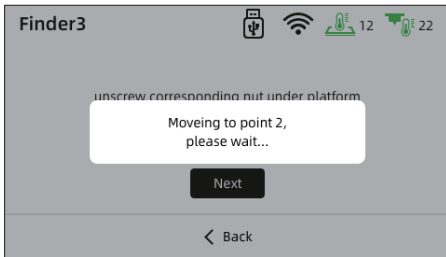

3. When the extruder moves to the second point, pull the A4 paper to feel the friction resistance. If the friction is too big to move, rotate nut anticlockwise to increase the distance between nozzle and build plate; if the friction is too small, rotate nut clockwise to reduce the distance between nozzle and build plate. It is better that pull the paper to feel the significant frictional resistance until the slight scratches appear without damage. Tap [Next] to do the third level point.

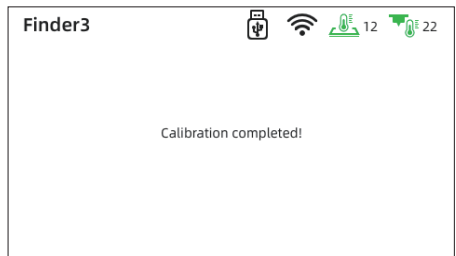
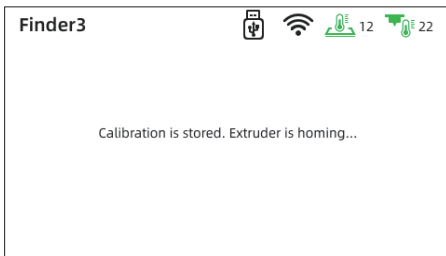

4. The third leveling point repeats the second point leveling operation until the three-point leveling is completed.

2.5 Loading Filament

Note Please ensure that the filament has been loaded in an appropriate approach.

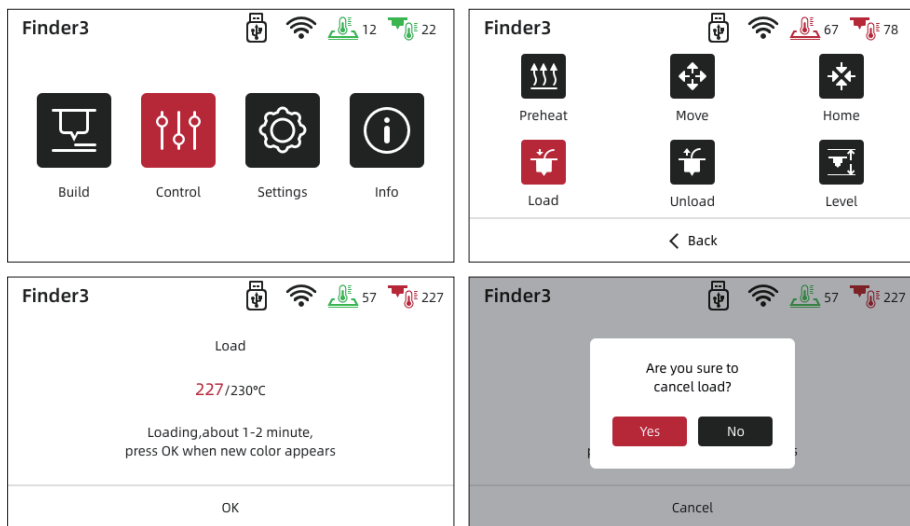

Tap [Control] - [Load]. It starts to load the filament when the targeted temperature reached. Do not stop loading when the nozzle extrudes the filament. It is suggested that extrude the filament evenly then tap [OK] to back to the homepage.

2.6 Software Installation

Method 1:

Find the FlashPrint installation package in the USB disk and select the version corresponding to your system to install.

Method 2:

You can download it from <https://www.flashforge.com/download-center>.

Chapter 3 First Print

⚠ Suggestions

1. Ensure that the build plate has been leveled before printing.
2. Please clean extruder before printing (Load the filament for a while to extrude all the melted filament you printed last time out of the extruder).
3. Do not leave the printer unattended during operation.

3.1 Print

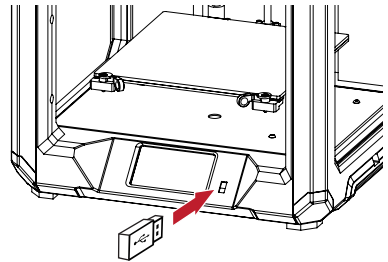
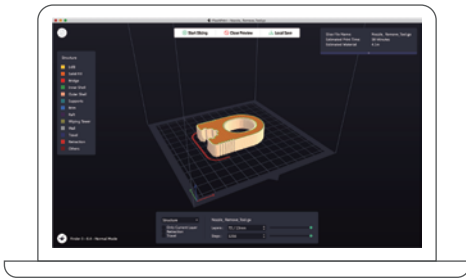

Decompressed the slicing software package in the USB flash drive and install it to your computer. Open the software, load the stl file for slicing, then saved the sliced file to the USB flash drive. Insert the USB flash drive.

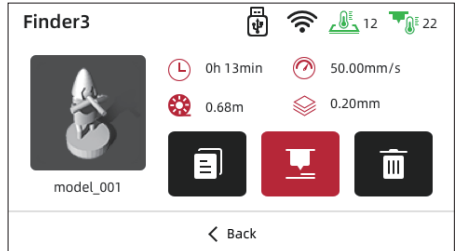
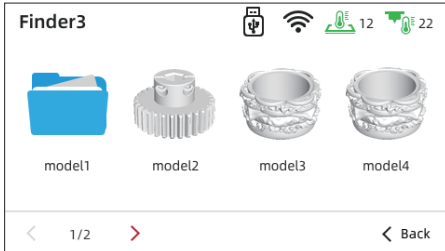
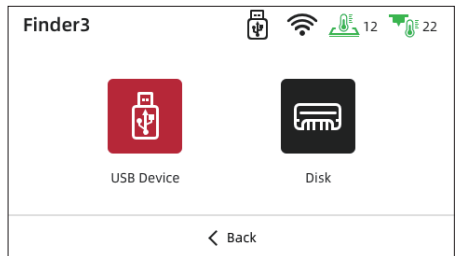
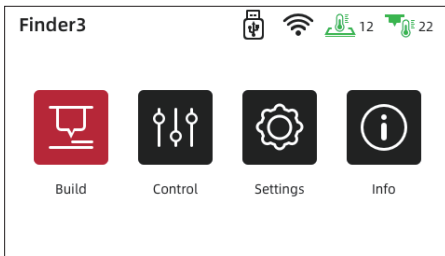

Tap [Build] - [USB Device], select model - [Build].

3.2 Unloading Filament

Please follow steps below if you need to unload filament in daily use.

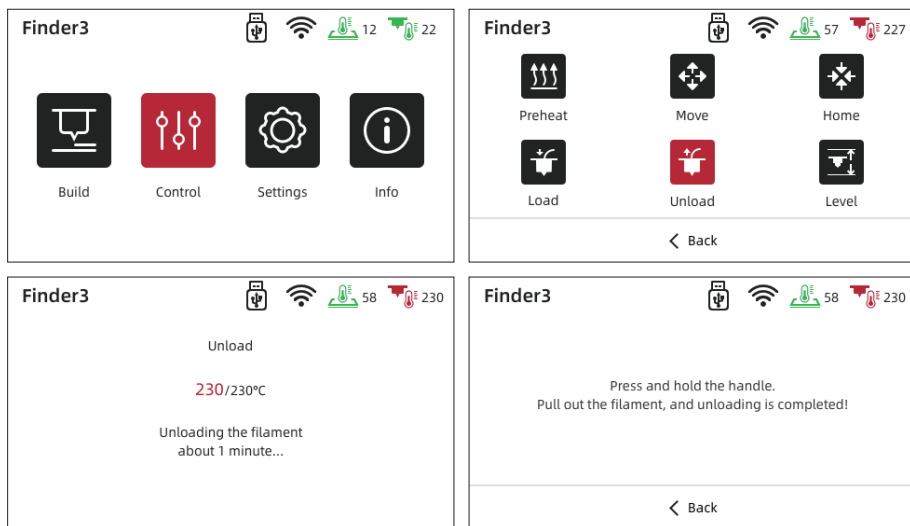

Tap [Control] - [Unload]. When the filament unload out of the filament feeding port, the unload operation is finished.



Note

After unload completed then load again, it is filament replacement.

3.3 Wi-Fi Connection

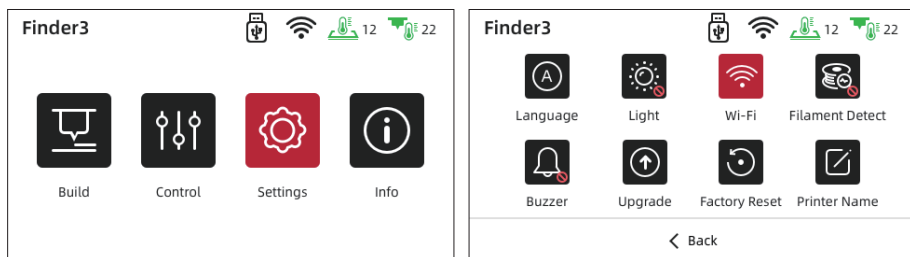

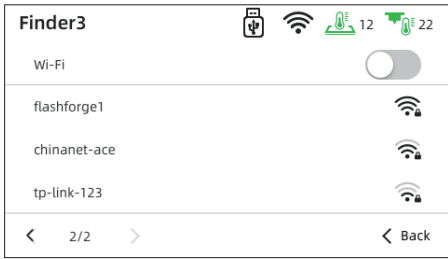

Tap [Settings] - [Wi-Fi], open the WIFI function. Choose the Internet and save the password.

3.4 Connect Printer by Wi-Fi

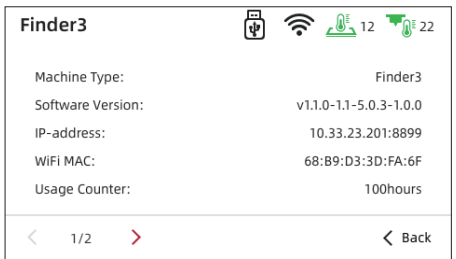
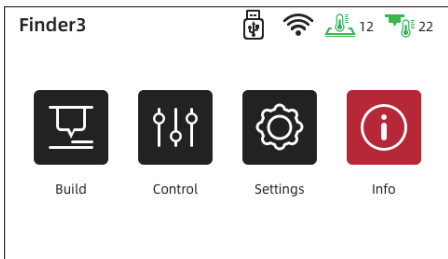

1. After the Wi-Fi connected successfully, tap [Info] and check the IP Address.

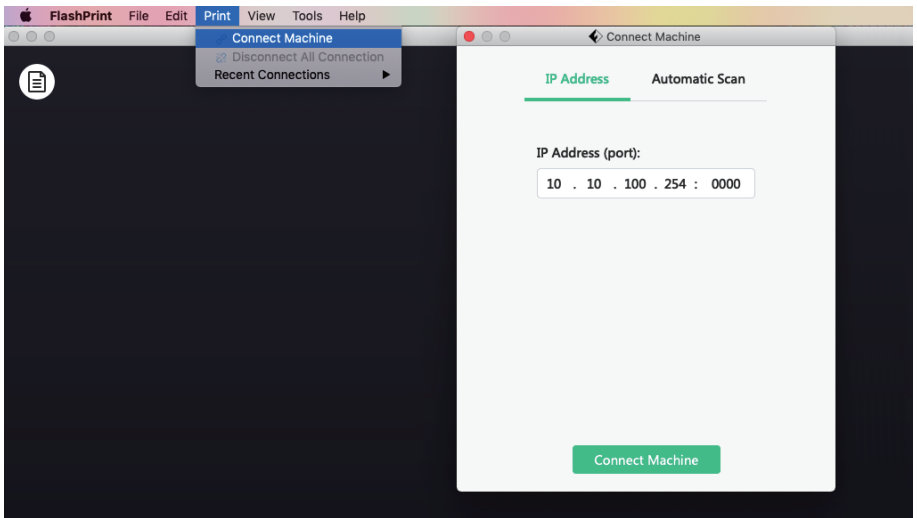

2. Open the FlashPrint 5, click [Print] - [Connect Machine], input the IP address and click the connect.
3. Click [Tools] - [Multi-Machine Control], you will see the status of device.

3.5 Firmware Upgrade

Method 1:

Get the firmware files:

Connect with aftersales and send email to support@flashforge.com

1. Copy the firmware into the blank USB flash disk.
2. Plug in the USB flash disk into the USB port of printer and reboot the printer, waiting for the upgrade process finished.
3. Plug out the USB flash disk after hearing three beeps, reboot printer again.
4. After the upgrade completed, please delete the firmware file in the USB flash disk to avoid upgrading repeatedly next time.

Method 2:

1. Connect the WIFI successfully (Refer to 3.3 Wi-Fi Connection);

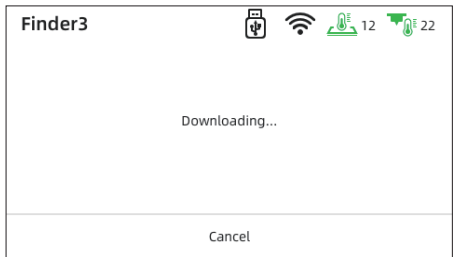
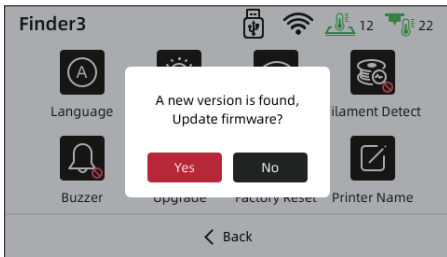
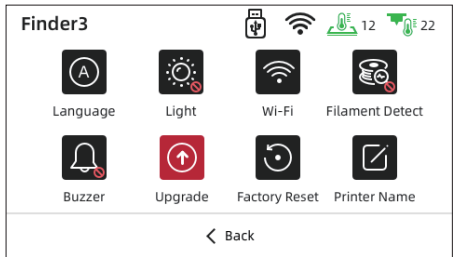
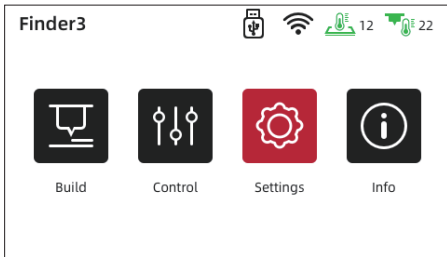

2. Tap [Settings] - [Upgrade], check the latest firmware; if there is a new firmware need to be upgraded, please tap [Yes] to upgrade.

3.6 Printing Notice

1. The adhesion of glass build plate may decrease after long time using. Please apply proper amount of glue to keep and improve the adhesion.
2. Warping issues may occur when print ABS filament in cold environment, you may use glue to enhance the adhesion. It's not recommended to print ABS filament at extremely low temperature environment, as print will fail when printed model getting away from the build plate.
3. There is a certain quivering on the build plate during the printing which may cause flatness changed. Thus please pay attention to the adhesion of the first layer when printing model; if the distance between build plate and nozzle is improper, please re-level it.
4. If printing effect is not accurate enough, check the tension of synchronous belt and make it neither too loose nor too tight.
5. If there is an error in the height of the Z-axis, please adjust the compensation of the Z-axis accurately.
6. Optimal temperature for printing is 18~30°C. Too high or too low temperature is not good for printing effect.
7. The lubricity of the X-axis guide rail will decrease after long time use, please apply an appropriate amount of grease to increase the lubricity.



Due to continuous firmware upgrades, the UI interface is subject to the actual situation.

Chapter 4 FAQ

Q: What if the files are garbled and cannot be read?

A: 1. The format of files after slicing is not compatible;
2. Repair the model before slicing.

Q: What if the model warps or is unable to stick to the build plate?

A: 1. The temperature of the build plate was too low; please rise its temperature;
2. Filament failed to adhere to the build plate, use glues to enhance the adhesion;
3. Distance between the build plate and the nozzle is too far or the build plate is not leveling enough; re-leveling the build plate accordingly.

Q: What if the screen turns dark?

A: 1. Please check whether the screen flat cable has those questions: loose, plugged in reverse, plugged in wrong position, tilted plugging;
2. Refresh the firmware to see if the screen can recover to normal;
3. Contact the after-sales personnel if necessary.

Q: What if the build plate cannot be heated?

A: Please check the digital display of the temperature. If the temperature is improper, please replace the thermistor. Otherwise, please replace the heating plate wires.

Q: What if the nozzle cannot be heated?

A: 1. Please check the temperature on display screen; if the temperature is shown abnormal, it is in the reason of thermistor. Please replace the thermistor and try again;
2. If the temperature is shown normal, it may be in the reason of heating cable. Please replace the heating cable and try again.

Q: What if the accuracy of model is not good?

A: Please ensure proper tension of the synchronous belt, neither loose nor tight.

Q: What if the axis cannot be moved?

A: 1. Check the wire of the electric motor;
2. Contact us by email listed.
Email: support@flashforge.com

Q: What if the files on the USB flash disk cannot be identified?

A: 1. Clean and wipe the USB flash disk;
2. Format the USB flash disk;
3. Replace the USB flash disk.

Q: What if knock and noise occur when nozzle returning to zero point?

A: 1. Check whether the zero sensor is knocked and broken;
2. Check the lines and see whether the noises stop when pressing the sensor by hand;
3. Contact us by email.
Email: support@flashforge.com

Q: What if offset occurs on the finished model?

A: 1. Check the tightness of the synchronous belt and ensure it is correctly installed;
2. Slice the model again;
3. Reduce print speed;
4. Make sure operating temperature doesn't exceed its assigned set-point temperature 30°C.

Q: Printer gets broken at the time of turning it on?

A: It might be caused by dialing error from switch power supply, please check whether the voltage is set to the correct value.

Q: Too much filament oozing?

A: 1. Drop the print temperature by 5~10°C;
2. Increase traveling speed, or increase the retraction length and speed.

Q: No filament coming out during printing?

A: 1. Lower the retraction length to avoid abrasion;
2. Check whether the extruder is clogged, use a needle to clean it if necessary.

Chapter 5 Support and Service

Flashforge team is on standby and ready to help you with any challenges you may have with your 3D printer. If the issues or questions are not covered in this User Guide, you can seek for solutions on our official website or contact us via telephone.

There are solutions and instructions to common issues that can be found in our knowledge base. Have a look first as most basic questions are answered there.
<http://www.flashforge.com>

The Flashforge support team can be reached by e-mail or phone between the working hours of 8:00 a.m. to 5:00 p.m. PST Monday through Saturday. In case you contact us during off-duty time, your inquiry will be answered the following business day.

Note: Changing different filament may caused extruder clogged, it is a normal issue, and only need to dredge the nozzle. (It's not owing to printer quality and not included in 400 hours lifespan range.)

Facebook Official Group Address: Flashforge Official User Group

Email: support@flashforge.com

Address: No.518 XianYuan Road, Jinhua City, Zhejiang Province, China

Note: Please provide the product serial number which is the barcode at the back of the printer before contacting our after-sales department.



目录

使用须知	21
法律申明	21
设备参数	22
开箱	23
第一章 设备简介	24
1.1 - 整机介绍	24
1.2 - 装箱清单	25
第二章 打印操作	26
2.1 - 丝料安装	26
2.2 - 打印平台	27
2.3 - 通电	27
2.4 - 调平	28
2.5 - 进丝	30
2.6 - 软件安装	30
第三章 首次打印	31
3.1 - 打印	31
3.2 - 退丝	32
3.3 - 连接Wi-Fi	32
3.4 - Wi-Fi连接电脑	33
3.5 - 固件更新方法	34
3.6 - 打印注意事项	35
第四章 故障检修	35
第五章 帮助与支持	37

使用须知

1. 请勿自行对打印机进行任何改装。请按照说明书操作，避免造成意外人身伤害和财产损失。
2. 在使用打印机时，请勿穿戴围巾、手套、珠宝装饰等容易卷入设备的物件。
3. 请勿在打印机工作时接触喷嘴和打印平台，防止出现高温烫伤。
4. 请勿将打印机放置在有可燃性气体、液体及灰尘的环境中（打印机运行产生的高温有可能会与空气中的粉尘、液体、可燃性气体反应引发火灾）。
5. 请勿将打印机放置在振动较大或其他不稳定的环境内，打印机晃动会影响打印质量。
6. 儿童及未经培训的人员请勿单独使用设备。
7. 请在通风环境下操作此设备，部分耗材打印过程中可能产生异味。
8. 请勿在开机状态下手动快速移动喷头和打印平台，避免打印机故障。
9. 请勿利用该打印机进行违法犯罪的活动。
10. 请勿利用该打印机制作食物储存类产品。
11. 请勿将打印模型放入口腔。
12. 在打印机进行进退丝操作时，喷头和平台请至少保持50mm的距离（距离过近，有可能会造成喷头堵塞）。
13. 请定期维护打印机，用干布进行清洁，拭去灰尘与导轨上的异物。

法律申明

- ◆ 用户无权对此使用手册进行任何修改。
 - ◆ 客户若自行拆装或改造设备造成任何安全事故，闪铸科技概不负责。未经闪铸科技允许，任何人不得对该手册进行修改或翻译。
 - ◆ 本手册受版权保护，闪铸科技对本手册保留最终解释权。
 - ◆ 后续因设备升级，闪铸科技保留对说明书修改的权利。
- ◆ 第一版（2022年1月）
©Copyright 2021浙江闪铸三维科技有限公司版权所有

设备参数

型号	发现者3
成型尺寸	190*195*200mm
成型技术	FDM
喷头数量	1
层厚	0.1mm-0.4mm
喷嘴直径	标配 0.4mm
精度	±0.2mm
打印材料	φ1.75mm PLA / PETG / TPU
支持格式	stl / obj / amf /3mf / fpp / bmp /png / jpg / jpeg
打印方式	内存打印 / U盘连接打印 / Wi-Fi联机打印
可兼容切片软件	FlashPrint / Cura / Simplify 3D
电源规格	输入：AC 115/230V 50/60Hz 输出：DC 24V
总功率	350W
热床温度	≤110°C
喷嘴温度	≤260°C
断电续打	支持
断料检测	支持
屏幕	4.3寸彩色触摸屏
语言切换	中文 / 英语 / 日语 / 法语 / 西班牙语 / 德语
电脑操作系统	Windows 7/10 / Mac OS
打印速度	≤180mm/s, 正常为50-80mm/s
定位精度	Z轴：0.0025mm, X/Y轴：±0.011mm
输出格式	.gx / .g / .gcode

开箱

1. 打开包装，取出说明书及U盘。
2. 拿起在运输中起保护作用的纸塑壳。
3. 取出打印机放置于桌面上，去除包装袋。
4. 取出顶部装有电源线的纸塑壳。
5. 从机器正面取出喷嘴下方的纸塑壳。
6. 用手托住打印平台，缓缓将其提升，以便于取出平台下方的纸塑壳。
7. 撕除机器四周的保护贴纸。
8. 剪断固定X轴同步带、Y轴同步带的扎带。
9. 剪断用来固定导轨的扎带。
10. 剪断用来固定平台的扎带。撕掉平台上的保护膜。
11. 至此开箱完成。请妥善保管配件及包装，以便于后续使用。

第一章 设备简介

1.1 整机介绍

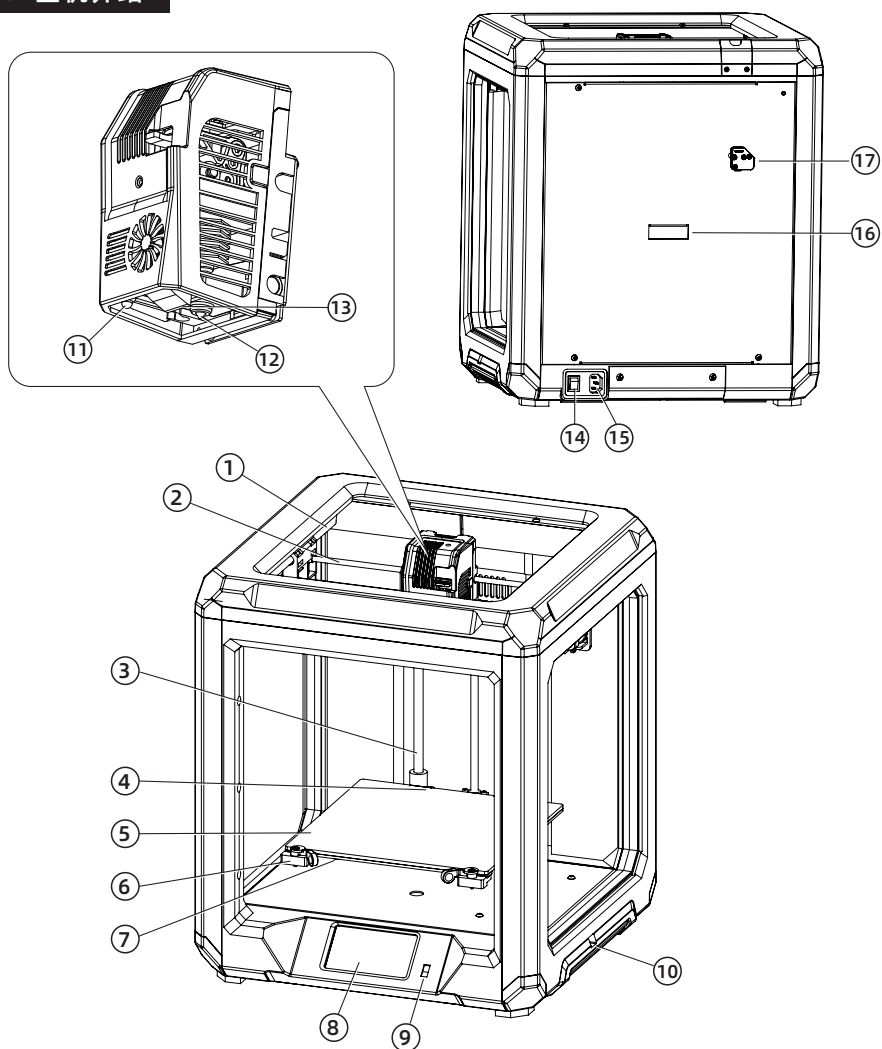

- | | | | |
|-------------|------------|------------|---------------|
| 1. Y轴导轨 | 2. X轴导轨 | 3. Z轴导轨 | 4. 平台限位卡扣 |
| 5. 打印平台 | 6. 固定卡扣 | 7. 调平螺母 | 8. 触摸屏 |
| 9. U盘接口 | 10. 电源拨码窗口 | 11. 喷头灯 | 12. 喷嘴 |
| 13. 涡轮风扇出风口 | 14. 电源开关 | 15. 电源输入端口 | 16. 丝盘固定轴安装接口 |
| 17. 丝料检测传感器 | | | |

1.2 装箱清单

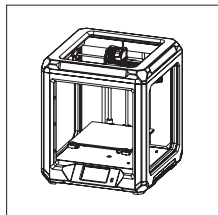

3D打印机

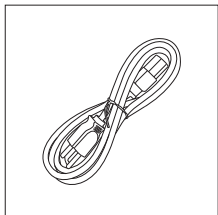

电源线



耗材



使用说明书

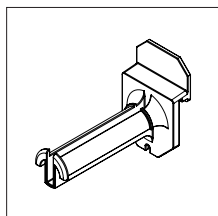

丝盘固定轴

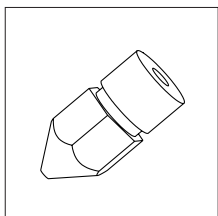

喷嘴

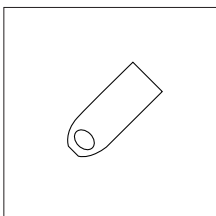

U盘

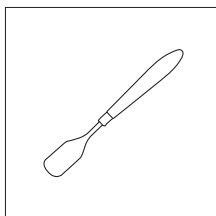

金属铲刀

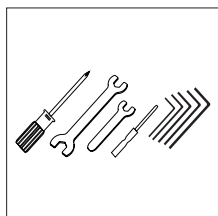

扳手和螺丝刀

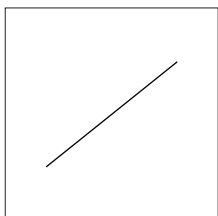

通针

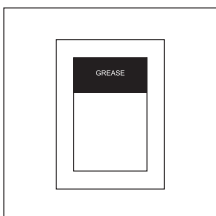

润滑脂

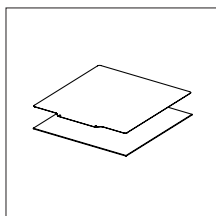

柔性可移除平台

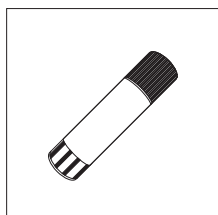

胶棒

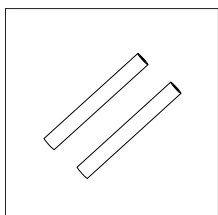

导丝管

第二章 打印前准备

2.1 丝料安装

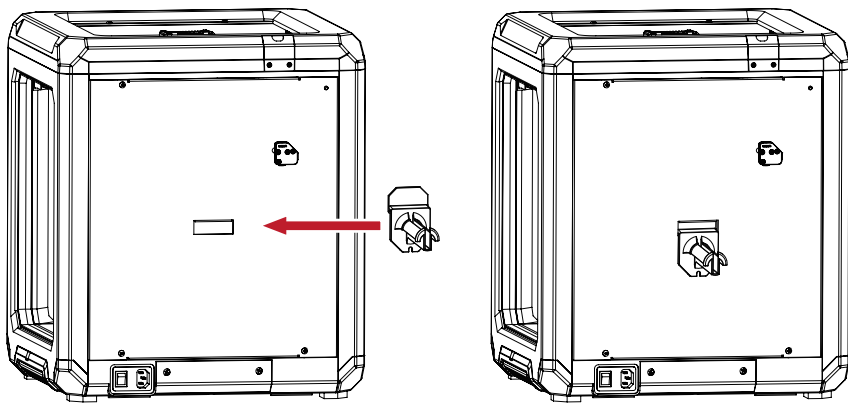

1. 将丝盘固定轴安装于打印机背部的安装接口上。

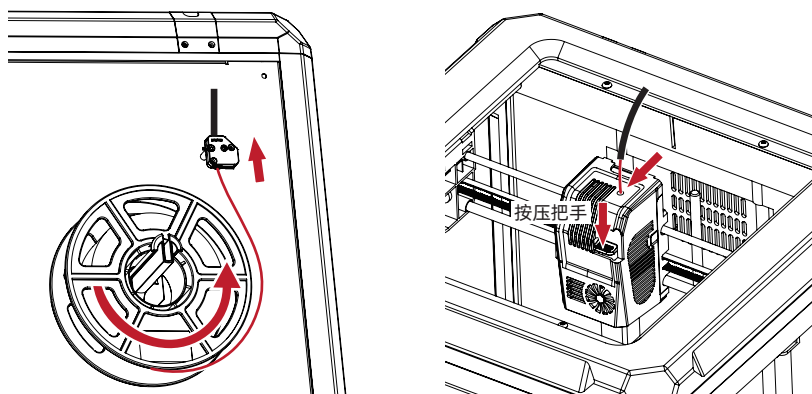

2. 将耗材穿过耗材进丝口，将耗材送至导丝管；拔出喷嘴导丝管，按压把手，将丝料插入喷头送丝轮中。

2.2 打印平台

Finder 3 默认安装玻璃平台，用户也可使用柔性可移除平台。

玻璃平台：底部更平整，但移除模型需要借助铲刀；若环境温度较低时，使用玻璃平台建议打印前涂抹胶水，以增加粘附力。

柔性可移除平台：利用磁性吸附，取下柔性钢板折弯可取下模型。

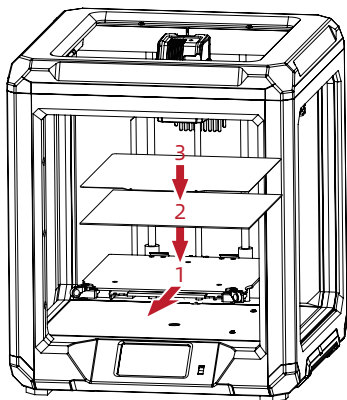

柔性可移除平台板的安装方式：

1. 将玻璃平台取下；
2. 将磁贴贴到加热板上方；
3. 柔性钢板可吸附于磁贴上。



注意 若从玻璃平台切换到柔性可移除平台时需要做调平与校准动作。

2.3 通电

插上电源线，拨动开关打开电源。当机器通电时，请勿断开连接线。

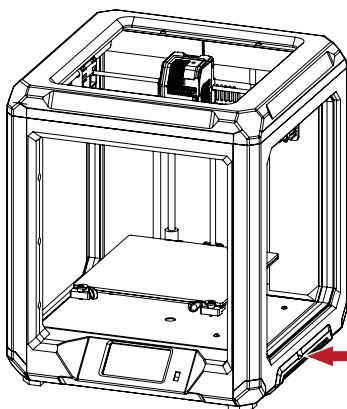

警告

- 选择正确的输入电压以匹配您的本地电源。
(115/230V)
- 如果电压设置不正确，可能会造成损坏。
- 连接电源线并将电源开关拨至 | 档即可开机。



2.4 调平

在触摸屏上依次点击【设置】-【语言】调整语言。



如何通过调平螺母调节打印平台

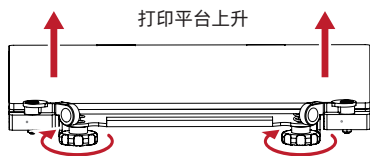

顺时针旋转螺母

打印平台上升，喷嘴与平台之间的间距变小

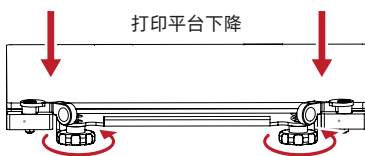

逆时针旋转螺母

打印平台下降，喷嘴与平台之间的间距变大



1. 取一张A4纸放在打印平台上，依次点击【控制】-【调平】，等待喷头移动到第一个调平点。



2. 轻轻滑动A4纸, 若没有明显摩擦阻力, 点击【↑】, 缩小喷嘴与打印平台之间的距离; 反之, 点击【↓】, 增加喷嘴与打印平台之间的距离, 直至滑动A4纸有明显摩擦阻力, 能拖动A4纸但不会划破。点击【下一步】, 完成第一点调平。



3. 当喷头移动到第二个调平点, 轻轻滑动A4纸, 若没有明显摩擦阻力, 顺时针旋转调平螺母, 缩小喷嘴与打印平台之间的距离; 反之, 逆时针旋转调平螺母, 增加喷嘴与打印平台之间的距离, 直至滑动A4纸有明显摩擦阻力, 能拖动A4纸但不会划破。点击【下一步】, 完成第二点调平。



4. 第三点调平重复第二点调平操作, 直至三点调平完成。

2.5 进丝

注意 在进丝前确认耗材安装正确，没有打结或卡住！

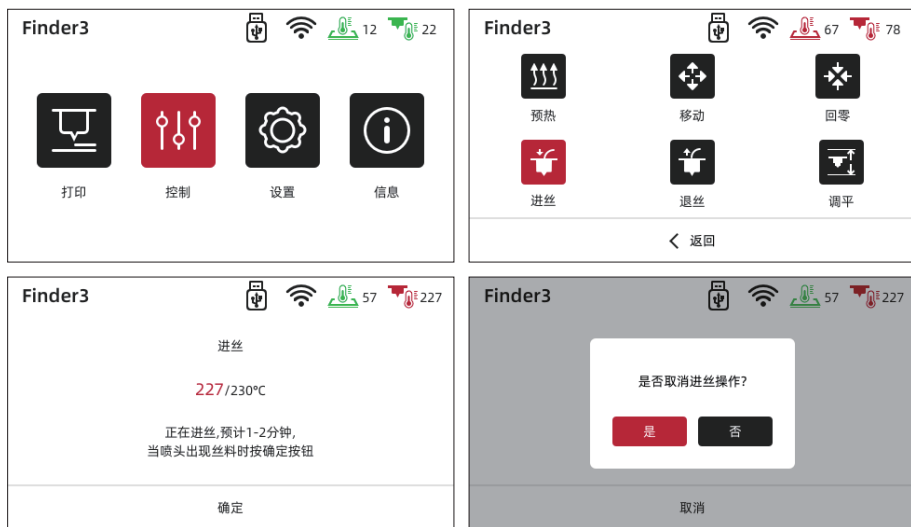

在首界面点击【控制】-【进丝】。喷头加热到预定的温度后会自动开始进丝。当喷嘴开始出丝时请勿停止进丝，直到耗材均匀出丝为止，点击【确定】，返回主界面。

2.6 软件安装

方法一

在U盘中找到FlashPrint软件安装包，选择对应的系统版本进行安装。

方法二

从官方网站 www.sz3dp.com 下载最新的切片软件。

第三章 首次打印

⚠️ 打印建议

1. 打印开始前请确保打印机已经完成调平；
2. 打印开始前请将喷头内的耗材清理干净（喷头内可能残留少量耗材，请进丝一段时间，确保上一次打印的耗材已全部挤出）；
3. 不允许在长时间无人看守的情况下使用3D打印机。

3.1 打印

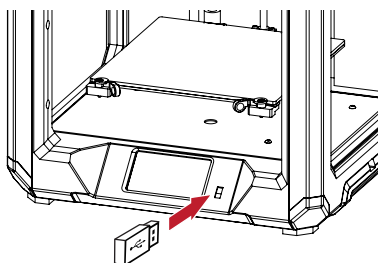
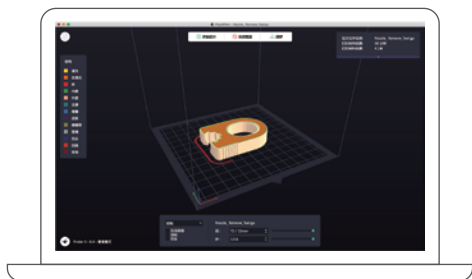

将U盘中的切片软件安装包，安装到电脑上。打开软件，导入stl文件进行切片，将切片后的文件存入U盘。将U盘插入机器。

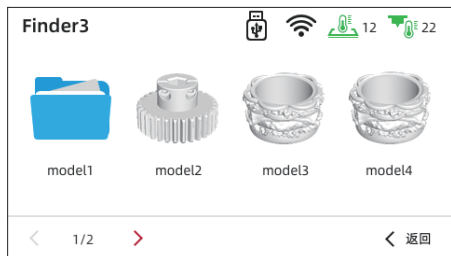

在首页面点击【打印】-【U盘】，选择模型（长按可多选）-【打印】。

3.2 退丝

在日常使用中，如果需要更换耗材，请按下列步骤操作。

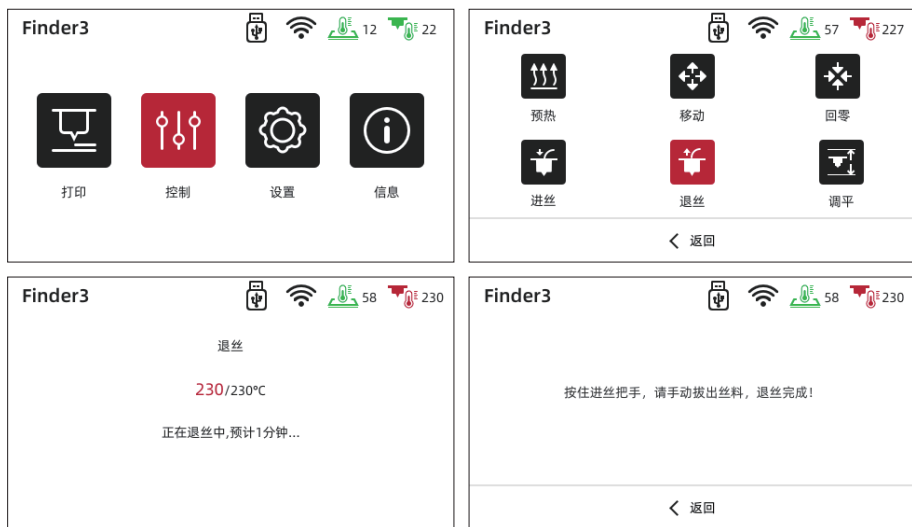

在首页面点击【控制】-【退丝】，等待自动退丝完成后点击【返回】完成退丝。



注意 退丝完成后执行进丝操作，即可完成耗材更换。

3.3 连接Wi-Fi



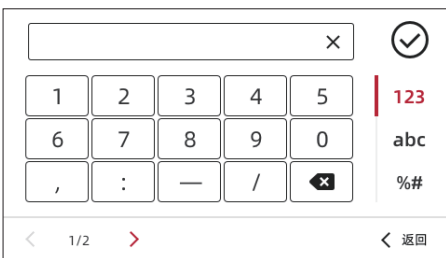
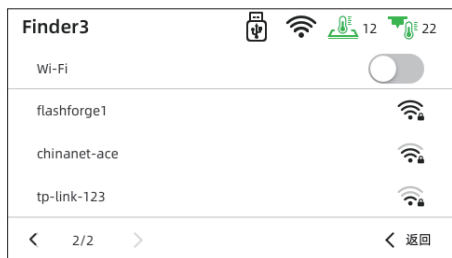

依次点击【设置】-【无线网络】，打开Wi-Fi功能。选择一组Wi-Fi，并输入密码，连接Wi-Fi。

3.4 Wi-Fi连接电脑



1. Wi-Fi连接成功后，点击【信息】，查看IP地址。



2. 打开切片软件FlashPrint 5，点击【打印】-【连接机器】，输入设备IP地址，点击【连接机器】。
3. 点击【工具】-【多机控制】，可查询到已连接设备的状态信息。

3.5 固件更新方法

方法一

固件下载：联系售后邮箱 support@flashforge.com

1. 将新固件包拷贝到空白的U盘中；
2. 将U盘插入打印机，重启打印机，打印机将自动更新，等待“更新完成”提示；
3. 蜂鸣3声后拔掉U盘，重启打印机；
4. 更新完成后删除U盘中的固件，避免下次开机重复更新。

方法二

1. 将打印机连接到网络（详见3.3 连接Wi-Fi）；



2. 依次点击【设置】-【升级】，在线查看是否有可升级固件包。如有，点击【确定】升级固件即可。

3.6 打印注意事项

1. 玻璃平台长期使用后粘附力将有所下降，请适量涂抹胶水增加粘附力。
2. 在低温环境中，打印ABS耗材容易发生翘边等异常情况，可涂抹胶水增强粘附力。不建议在温度过低的环境打印ABS材料，模型容易从平台脱离。
3. 打印平台因在打印过程中可能存在抖动导致平面度发生变化。打印时请注意第一层的粘附是否正常；若不正常，请重新调平。
4. 若打印成品在尺寸上有较大误差，请先确认同步带安装是否异常，是否太宽松或者过紧。若是，请调节至合适状态。
5. 若Z轴高度尺寸有误差，请对Z轴进行精度补偿。
6. 建议打印环境温度为18-30°C，过高或过低的环境温度，都会影响打印质量。
7. X轴导轨长期使用后润滑度将有所下降，请适量涂抹润滑脂增加润滑度。

⚠ 注意 因固件持续升级，UI界面以实际为准。

第四章 故障检修

Q：文件乱码，读取不了？

- A：1. 文件切片格式不匹配；
2. 切片前修复模型。

Q：打印模型起翘，粘不住打印平台怎么办？

- A：1. 平台温度设置太低，请加高平台温度；
2. 材料本身不粘平台（建议涂抹胶水，增强粘附力）；
3. 平台与喷嘴距离太大，平台未调平，请重新调平。

Q：黑屏或显示不良怎么办？

- A：1. 检查屏幕线束是否松动，重新插拔一下；
2. 刷新一下固件，是否能恢复，若不能请联系售后人员。

Q：热床无法加热？

- A：1. 查看温度显示是否异常，若异常则热敏电阻损坏，需要更换热敏电阻；
2. 温度显示正常不加热，加热板线损坏，需更换加热板线。

Q: 喷嘴不加热?

- A: 1. 查看温度显示是否异常, 若异常则热敏电阻损坏, 需要更换热敏电阻;
2. 温度显示正常不加热, 加热管线损坏, 需更换加热管线。

Q: 模型打印尺寸不良怎么办?

- A: 确认同步带是否异常松或太紧, 调整到合适状态。

Q: 轴无法运动。

- A: 1. 检查电机线束是否插好;
2. 联系技术支持。

Q: U盘中文件无法识别?

- A: 1. 擦拭U盘; 2. 格式化U盘; 3. 更换U盘。

Q: 回零一直在撞击, 停不下来, 有异响产生。

- A: 1. 确认回零传感器是否有问题, 是否有碰撞到传感器;
2. 检查线路是否异常, 手动按压传感器查看是否停止;
3. 联系技术支持。

Q: 模型打印偏移怎么办?

- A: 1. 确认同步带张紧力, 确认同步带是否安装错误;
2. 打印模型重新切片;
3. 降低打印速度;
4. 确认机器使用环境温度是否超过机器限定最高温度30°C。

Q: 机器通电就烧坏了。

- A: 开关电源拨码不正确, 检查电压是否拨到正确的电压值。

Q: 模型打印拉丝严重。

- A: 1. 适当调低打印温度5-10°C;
2. 适当调高空走速度, 或者提升回抽速度以及回抽值。

Q: 模型打印中不出丝了。

- A: 1. 适当调低回抽值, 回抽值过大容易磨损;
2. 确认喷头是否堵塞, 若堵塞需使用通针清理。

第五章 帮助与支持

闪铸专业的售后服务人员及业务员随时为您待命，非常乐意为您解决在您使用过程中遇到的任何问题。如果你的问题从用户手册中找不到答案，你可以进入我们的官方网站来搜索问题的解决方案，当然您也可以通过电话或QQ联系我们。

在我们的官网中可以找到一些常见问题的说明和解决方法。您的许多问题都可以在闪铸科技官方网站 www.sz3dp.com 得到解决。

您可以在周一到周六的上午8:00到下午5:00的时间段通过电话和QQ来联系闪铸的售后团队，为您解决问题。如果您刚好在下班时间联系我们，我们将在下一个工作日的第一时间给您反馈，为您解决问题，若造成不便，我们万分抱歉。

提示：由于更换不同的丝料，会有少量杂质残留在喷头中造成喷头堵塞，疏通后即可，不属于质量问题，不在400小时寿命范围内，若用户使用时存在该问题，请联系售后，并在售后的指导下完成疏通工作。

售后服务热线：400-8866023

售后客服QQ：2850862986 / 2850863000 / 2853382161

3D爱好者QQ群：206773820

公司地址：浙江省金华市婺城区仙源路518号

提示：联系售后时，需提供产品序列号，也就是打印机背部的条形码。



S/N: FFAD*****



Follow us

Zhejiang Flashforge 3D Technology Co., Ltd.

Address: No.518 XianYuan Road, Jinhua City, Zhejiang Province, China

Service Hotline: +86 579 82273989

support@flashforge.com